

Canon

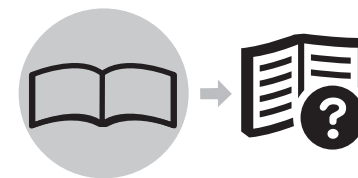
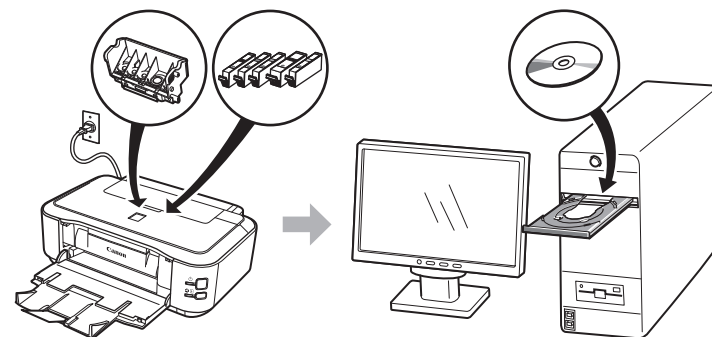

Photo Printer

PIXMA iP3600 series

Getting Started

=Read Me First=



Make sure to read this manual before using the printer. Please keep it in hand for future reference.



■ Symbols

The following symbols are used to mark important instructions. Observe these instructions.



Instructions that, if ignored, could result in personal injury or material damage.



Instructions that must be observed for safe operation.



Additional explanations.



Descriptions for operations that take some time to complete.

- Microsoft is a registered trademark of Microsoft Corporation.
- Windows is a trademark or registered trademark of Microsoft Corporation in the U.S. and/or other countries.
- Windows Vista is a trademark or registered trademark of Microsoft Corporation in the U.S. and/or other countries.
- Macintosh and Mac are trademarks of Apple Inc., registered in the U.S. and other countries.

Model Number: K10322(IP3600)

Contents

1 Check the Included Items



2 Turn the Power On

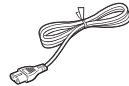

3 Install the Print Head



4 Install the Ink Tanks



5 Install the Software



6 Loading Paper



After Installing the Printer

Check the Included Items

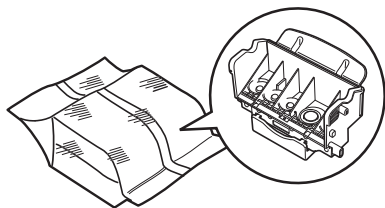

Print Head

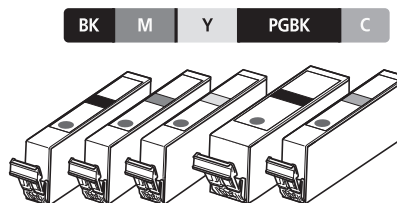

ink tank

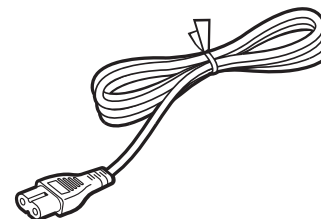

power cord

- Manuals
- Setup CD-ROM (containing the drivers, applications and on-screen manuals)
- Warranty



-
- Before turning on the printer, remove all the orange tapes and the protective sheets.



-
- A USB cable is necessary to connect the printer with your computer.
-

2

Turn the Power On



1

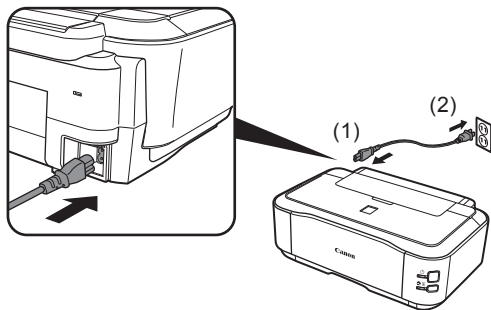

Plug in the power cord on the left side at the back of the printer and connect the other end to the wall outlet.



- Do NOT connect the USB cable at this stage.

2

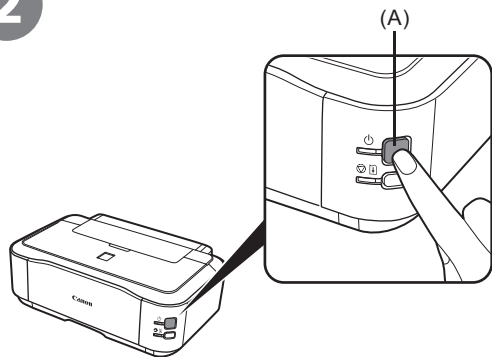

Press the **ON** button (A) to turn on the printer.



- The printer may make some operating noises. This is normal operation.

3

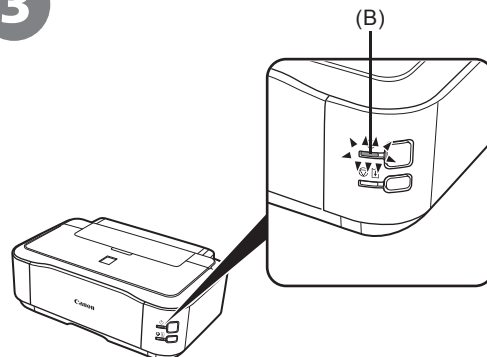

Confirm that the **POWER** lamp (B) lights green.

3

Install the Print Head

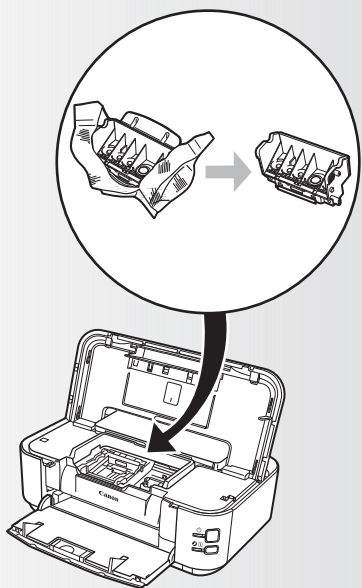

- Do not handle the Print Head roughly such as applying them excessive pressure or dropping them.

1

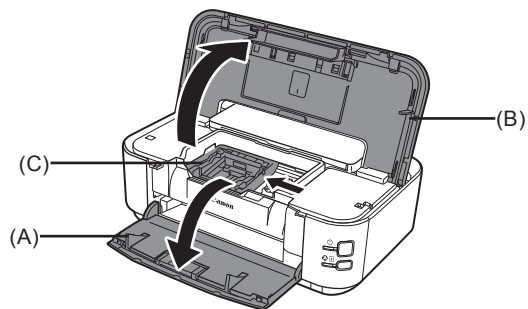

Open the Paper Output Tray (A) and the Top Cover (B).

The Print Head Holder (C) comes out. (This is where you install the Print Head.)



- The Print Head Holder makes a noise as it moves. This is normal operation.

2

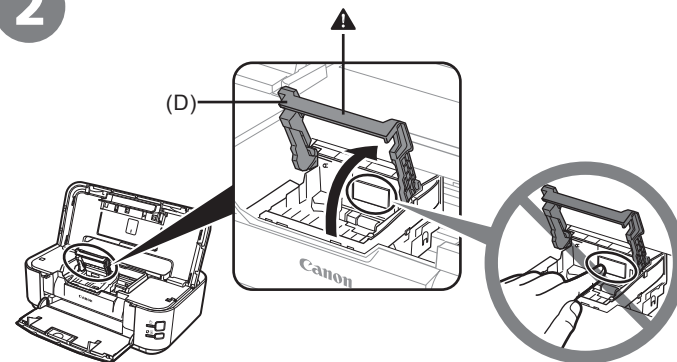

Raise the Print Head Lock Lever (D).



- Firmly raise the Print Head Lock Lever until it stops. (The Print Head Lock Lever may feel heavy.)



- If the Print Head Holder does not move, make sure that the printer is turned on.

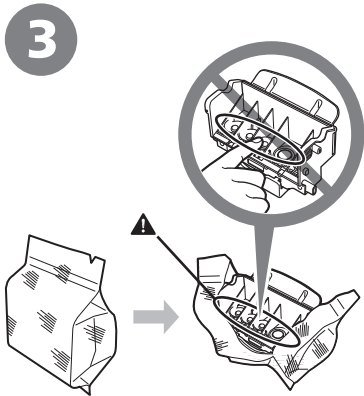

Remove the Print Head from the silver package.

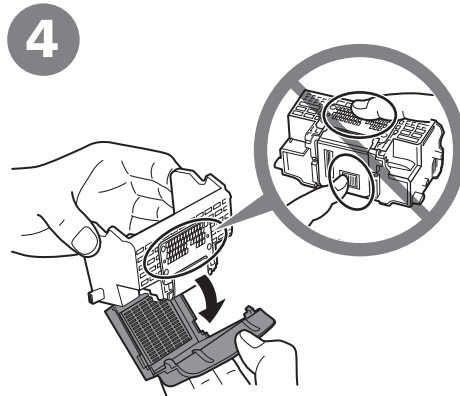

Remove and discard the orange protective cap.

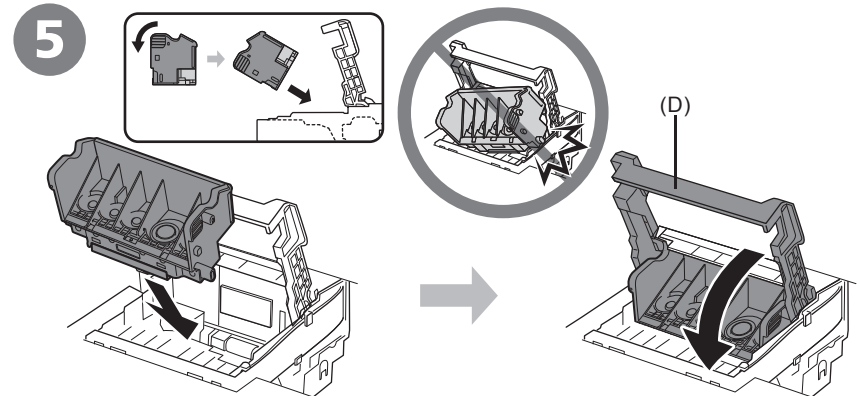

Tilt the Print Head and set it in place. Lower the Print Head Lock Lever (D) completely.



- There may be some transparent or light blue ink on the inside of the bag the Print Head comes in, or the inside of the protective cap - this has no effect on print quality. Be careful not to get ink on yourself when handling these items. Be careful not to stain your hands.



- Do not to knock the Print Head against the sides of the Holder.
- Pinch the Print Head Lock Lever firmly and lower it gently.
- Once you have installed the Print Head, do not remove it unnecessarily.

4

Install the Ink Tanks

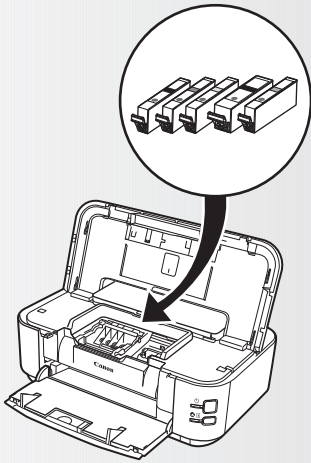

- Do not handle the ink tanks roughly such as applying them excessive pressure or dropping them.



- If the Print Head Holder moves to the right, close and reopen the Top Cover.
- Be sure to use the supplied ink tanks.

1

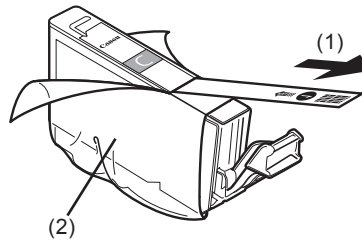

Pull the orange tape (1) in the direction of the arrow to peel off the protective film and remove the film (2) completely.

2

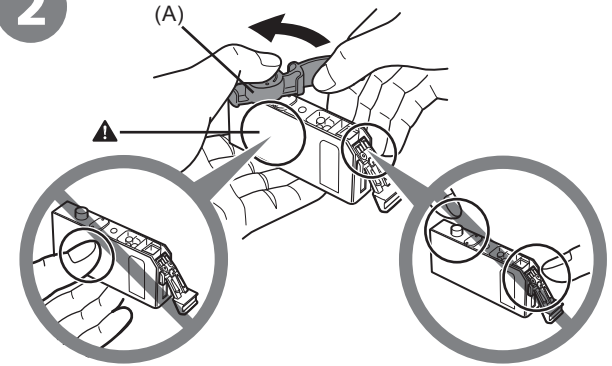

While pressing down with your left thumb, twist off the orange protective cap (A) located on the bottom of the ink tank.



- Do not hold the sides of the ink tank; ink may splash.

3 Install the Ink Tank

BK M Y **PGBK** C

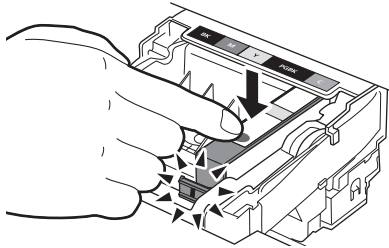

Press the **PUSH** mark on the ink tank until it clicks into place.

Make sure the **Ink** lamp lights red.



- Match the labels when installing.

4

BK M Y **PGBK** C

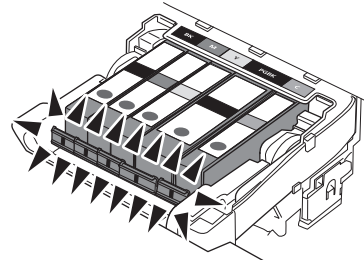

Install all the other ink tanks in the same way.

Install all the ink tanks.



- Once you have installed the ink tanks, do not remove them unnecessarily.



- Make sure all the **Ink** lamp lights red.

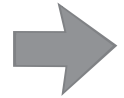

4

Install the Ink Tanks

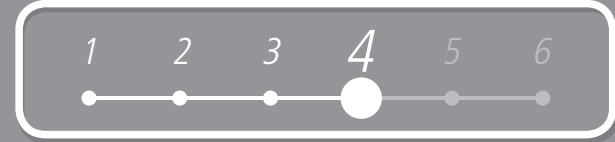

5

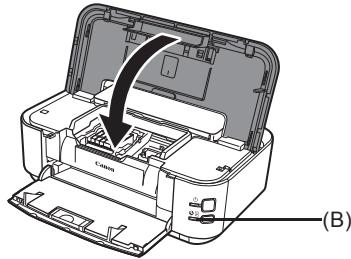

Close the Top Cover.



- Wait until the **POWER** lamp lights green (about 4 minutes) and go to the next step.
- The printer may make some operating noises when preparing to print. This is normal operation.



- If an **Alarm** lamp (B) flashes orange, make sure that the Print Head and the ink tanks are correctly installed.

6

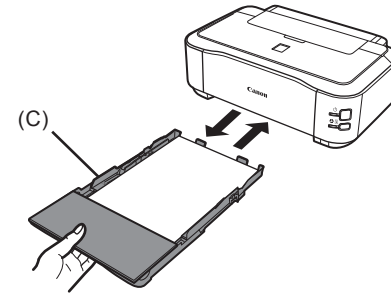

Load three or more sheets of A4 or Letter-sized plain paper into the Cassette (C).



- For details, refer to "6 Loading Paper" on page 22.
- Close the Paper Output Tray to make it easier to pull out the Cassette.

5

Install the Software



To use the printer by connecting it to a computer, software including the drivers needs to be copied (installed) to the computer's hard disk.

The screens below are based on Windows Vista operating system Ultimate Edition (hereafter referred to as "Windows Vista") and Mac OS X v.10.5.x.



- Quit all running applications before installation.
- You need to log on as the administrator (or a member of the Administrators group).
- Do not switch users during the installation process.
- It may be necessary to restart your computer during the installation process. Follow the on-screen instructions and click **OK**, and do not remove the *Setup CD-ROM* during restarting. The installation resumes from where it left off when your computer has been restarted.
- Mac OS 9, Mac OS X Classic environments, or Mac OS X v.10.3.8 or earlier are not supported.

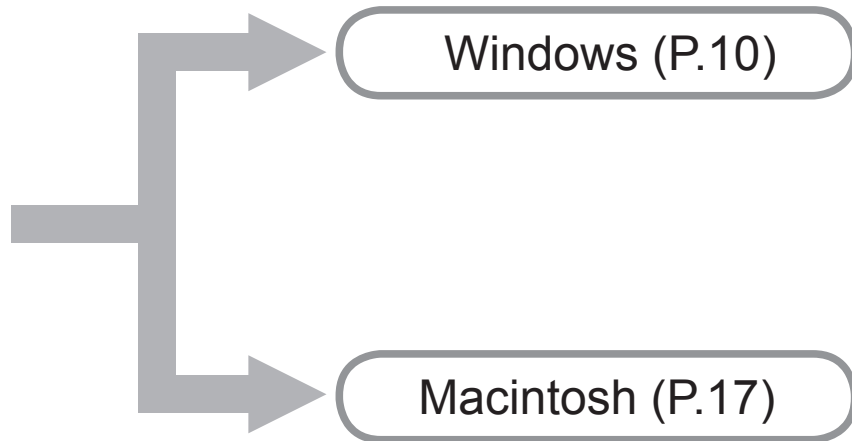

5

Windows

If the **Found New Hardware** or **Found New Hardware Wizard** screen appears:



- 1 Remove the USB cable connected to your computer. The screen may close. In this case, proceed from ①.
- 2 Click **Cancel** to quit the screen.
- 3 Proceed from ①.

1

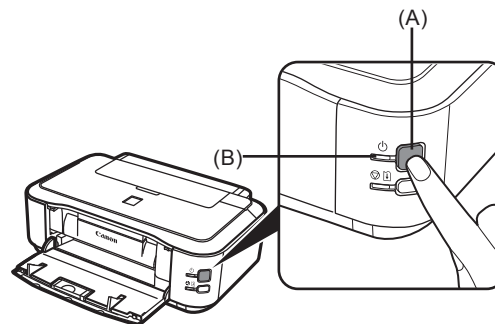

Press the **ON** button (A) to **TURN OFF THE PRINTER** and turn on the computer, then insert the *Setup CD-ROM* into the CD-ROM drive.

The setup program should run automatically.



- Operating noise continues for about 30 seconds until the printer turns off. Make sure that the **POWER** lamp (B) stops flashing.



- If the program does not start automatically, double-click the CD-ROM icon on the computer. When the CD-ROM contents appear, double-click **MSETUP4.EXE**.

2 Windows Vista

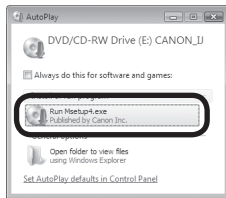

AutoPlay screen appears, click **Run Msetup4.exe**.

3 Windows Vista

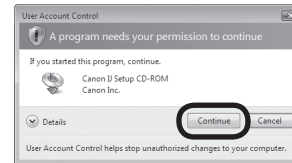

User Account Control screen appears, click **Continue**.

If the same screen reappears in subsequent steps, click **Continue**.

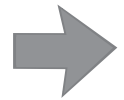

4

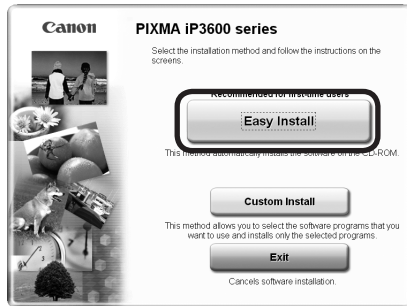

Click **Easy Install**.

The drivers, application software, and on-screen manuals are installed automatically.



- If you want to select particular items to install, click **Custom Install** and follow the on-screen instructions to proceed with the installation.

5

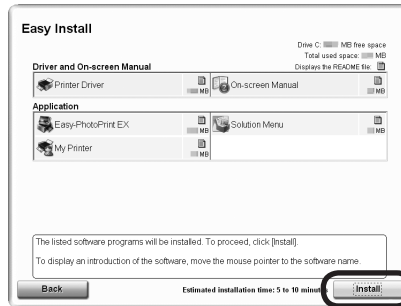

Click **Install**.

Move the cursor over items to display explanations.

6

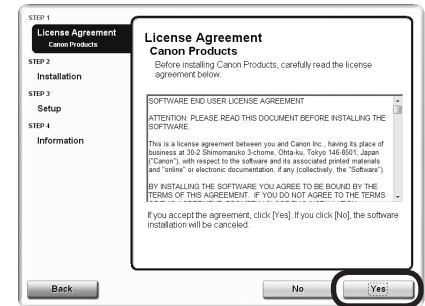

Read the **License Agreement** screen carefully and click **Yes**.

Installation starts.



- Follow any on-screen instructions to install the software.

7

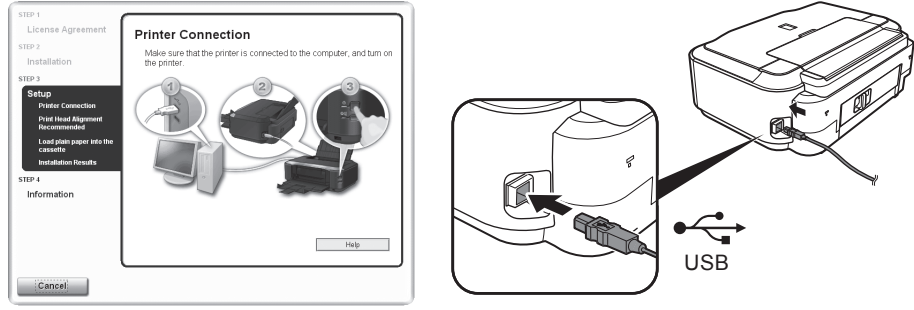

When the **Printer Connection** screen appears, connect one end of the USB cable to the computer, the other to the printer, then **TURN THE PRINTER ON**.



- It takes about 20 seconds for the **POWER** lamp to light green.
- When the printer is recognized by the computer, a message appears on the screen.
- If you cannot go to the next procedure after 10 minutes, click **Help** and confirm the message.



- The USB port is located on the right side at the back of the printer.

8

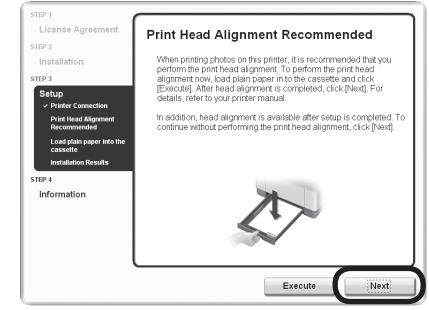

Click **Next**.



- For better print results, it is recommended that you align the Print Head before printing photos. To align the Print Head, click **Execute**. Follow the steps in "Aligning the Print Head" on page 29 for alignment.
- You can perform Print Head Alignment at any time. For details, refer to the on-screen manual: *Basic Guide*.



5

Windows

9

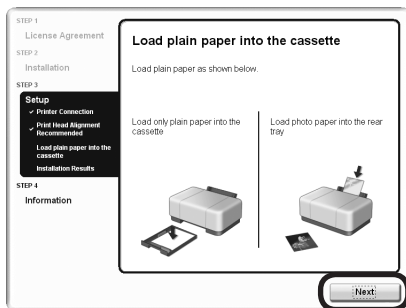

When the **Load plain paper into the cassette** screen appears, load plain paper in the Cassette and click **Next**.



• For details, refer to "6 Loading Paper" on page 22.

10

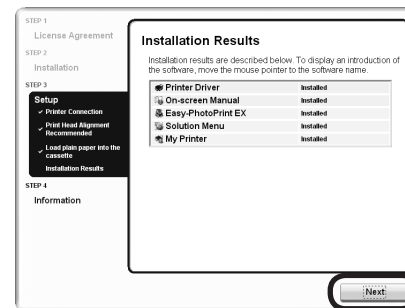

Click **Next**.

It may take a while for the next screen to appear. Click **Next** only once.

11

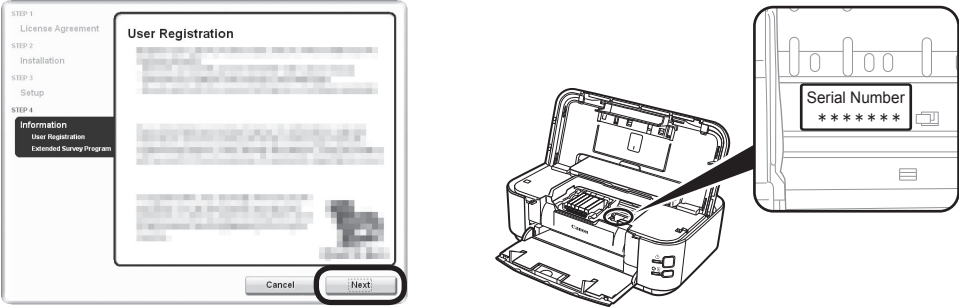

Click **Next**.

If connected to the Internet, the user registration page appears. Follow the on-screen instructions to register your product. You will need your product serial number, which is located on the inside of the printer.



- Internet connection is required. (Connection fees apply.)



- To register later, click **Cancel**. User Registration can be started from the Solution Menu icon. For details, refer to "Solution Menu" on page 26.

12

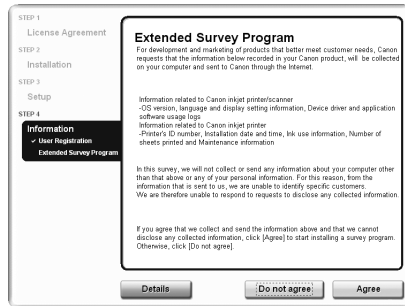

When the **Extended Survey Program** screen appears, confirm the message.

If you can agree, click **Agree**.

If you click **Do not agree**, the **Extended Survey Program** will not be installed. (This has no effect on the printer's functionality.)

13



Click **Exit**.

If Restart is displayed, make sure that the **Restart the system now (recommended)** check box is selected, then click **Restart**. After restarting the computer, remove the *Setup CD-ROM* and keep it in a safe place.

Next, read "6 Loading Paper" on page 22!

1

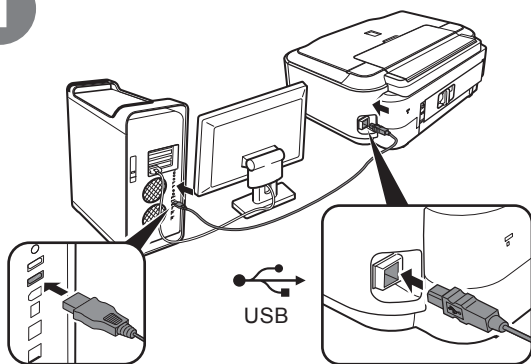

Connect one end of the USB cable to the computer and the other to the printer, then turn on the computer and insert the *Setup* CD-ROM into the CD-ROM drive.

Make sure the printer is turned on.



- The USB port is located on the right side at the back of the printer.

2

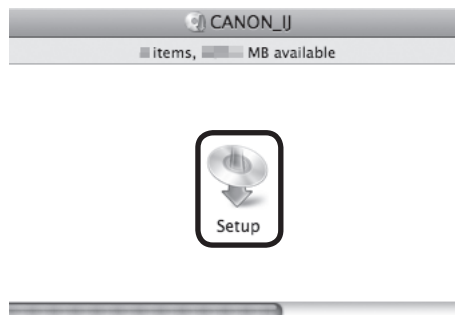

Double-click the **Setup** icon.

If the CD-ROM folder does not open automatically, double-click the **CANON_IJ** icon on the desktop.

3



Enter your administrator name and password. Click **OK**.

If you do not know your administrator name or password, click **Help**, then follow the on-screen instructions.



5

Macintosh

4

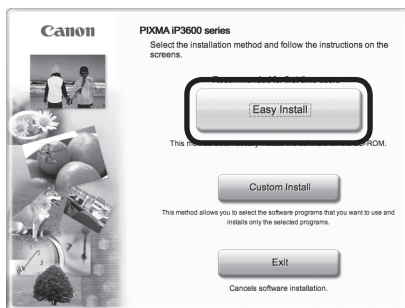

Click **Easy Install**.

The drivers, application software, and on-screen manuals are installed automatically.



- If you want to select particular items to install, click **Custom Install** and follow the on-screen instructions to proceed with the installation.

5

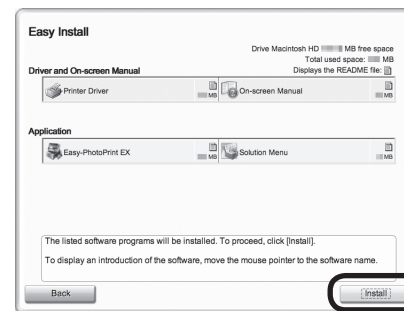

Click **Install**.

Move the cursor over items to display explanations.

6

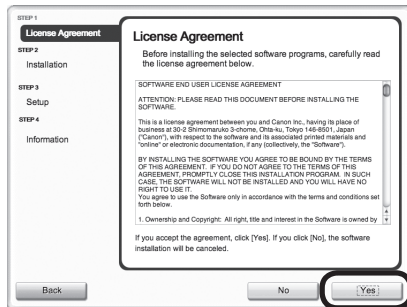

Read the **License Agreement** screen carefully and click **Yes**.
Installation starts.



- Follow any on-screen instructions to install the software.

7

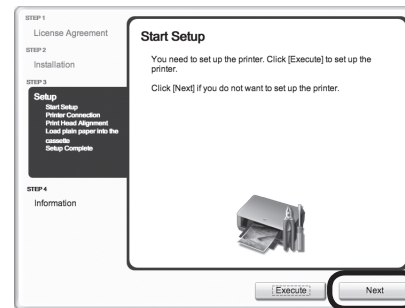

Click **Next**.



- For better print results, it is recommended that you align the Print Head before printing photos. To align the Print Head, click **Execute**. Follow the steps in "Aligning the Print Head" on page 29 for alignment.
- You can perform Print Head Alignment at any time. For details, refer to the on-screen manual: *Basic Guide*.



5

Macintosh

8

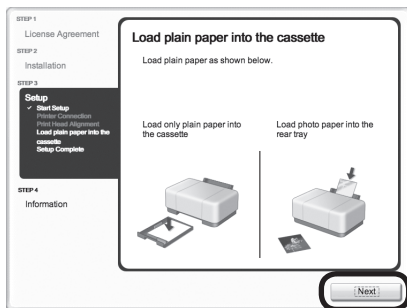

When the **Load plain paper into the cassette** screen appears, load plain paper in the Cassette and click **Next**.



• For details, refer to "6 Loading Paper" on page 22.

9



Click **Next**.

10

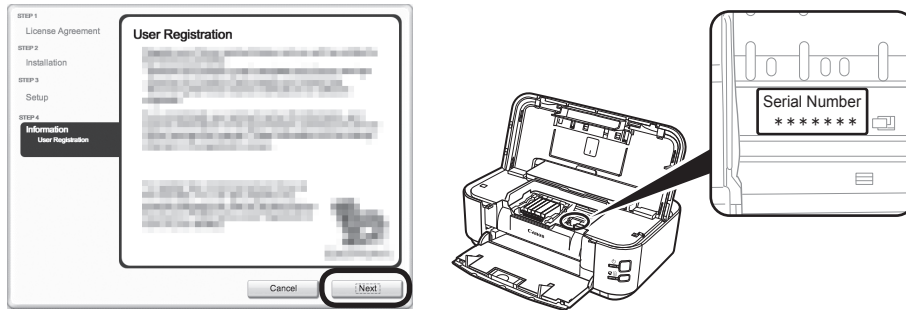

Click **Next**.

If connected to the Internet, the user registration page appears. Follow the on-screen instructions to register your product. You will need your product serial number, which is located on the inside of the printer.



- Internet connection is required. (Connection fees apply.)



- To register later, click **Cancel**. User Registration can be started from the Solution Menu icon. For details, refer to "Solution Menu" on page 26.

11

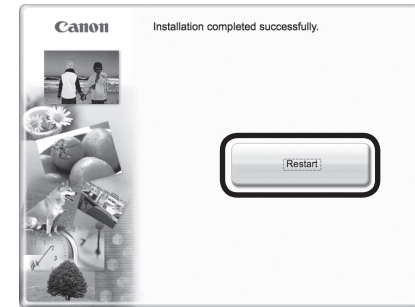

Click **Restart**.

Click **Restart** to restart the computer. After restarting the computer, remove the *Setup CD-ROM* and keep it in a safe place.

Next, read "6 Loading Paper" on page 22!

6 Loading Paper

This section explains how to load paper in the Cassette (A) and Rear Tray (B).

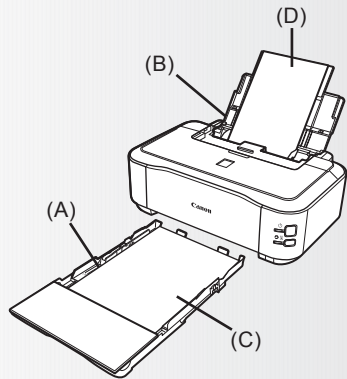

The Cassette (A) supports plain paper (C) only. To print on Photo Paper / Hagaki (D), be sure to load it in the Rear Tray (B).

1 Load in the Cassette

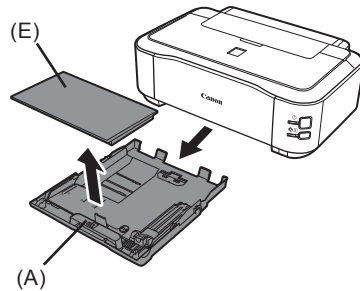

Pull out the Cassette (A) and remove the Cover (E).

2

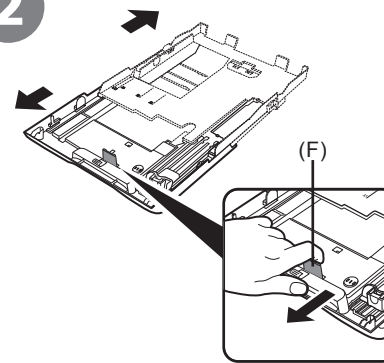

Pull the Tab (F) in the direction of the arrow and extend the Cassette.

3

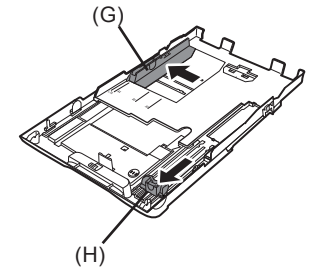

Move the Paper Guides (G) and (H) to both edges.

4

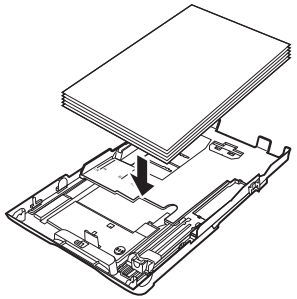

Load paper.



- Load paper with the printing side facing down.

5

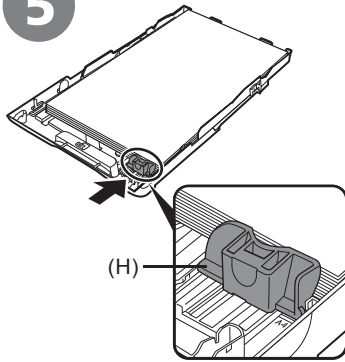

Slide the Paper Guide (H) to align with the mark of paper size.

The Paper Guide (H) will stop when it aligns with the corresponding mark of paper size.



- There may be a little space between the Paper Guide and the paper stack.

6

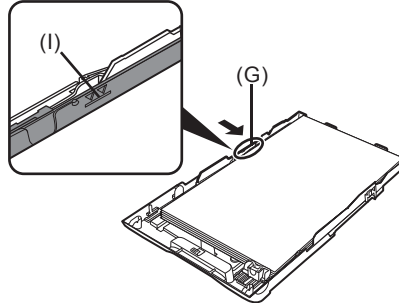

Slide the Paper Guide (G) against left edge of the paper.

Do not exceed the Load Limit Mark (I).



- To print on speciality paper, be sure to load it in the Rear Tray.

7

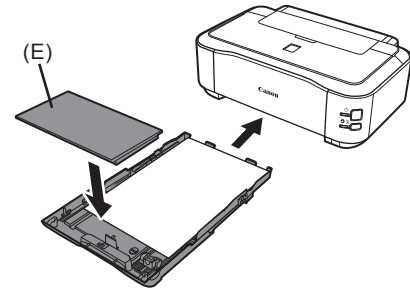

Attach the Cover (E) and insert the Cassette into the printer until it clicks into place.

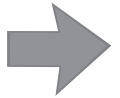

6 Loading Paper



8 Load paper in the Rear Tray

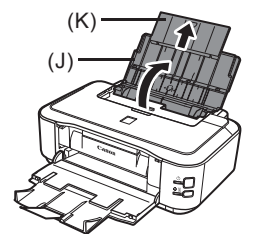

Open the Rear Tray Cover (J), and pull up the Paper Support (K).

9

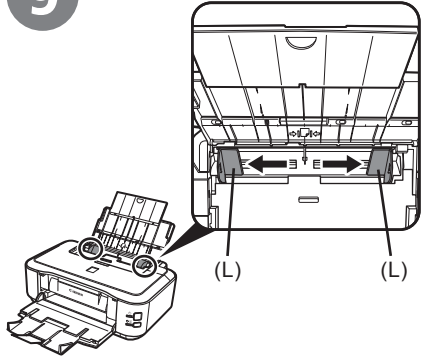

Move the Paper Guides (L) to both edges.

10

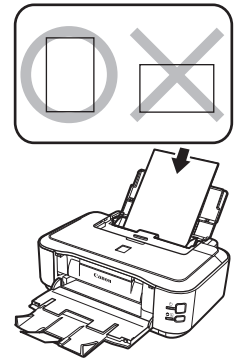

Load paper in the center of the Rear Tray.



- Load paper in portrait orientation with the printing side facing up.

11

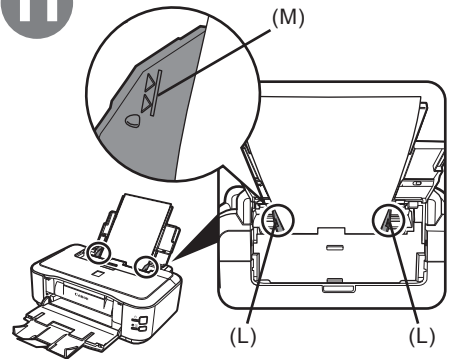

Slide the left and right Paper Guides (L) against both edges of the paper.

Do not exceed the Load Limit Mark (M).



- For details on media sizes and types you can use, refer to "Loading Paper" in the on-screen manual: *Basic Guide*.

Printer installation is now complete!



After Installing the Printer

■ Manuals

Safety Precautions

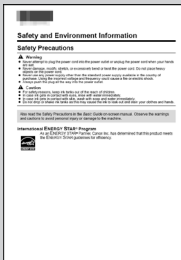

Safety and Environment Information

For proper use, read safety precautions before using the product.

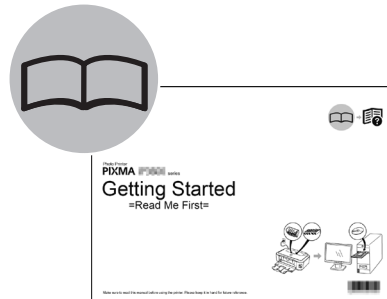

Getting Started (this manual)

Describes how to set up and use your printer. Introduces the printer and its functions, the included manuals and application software.

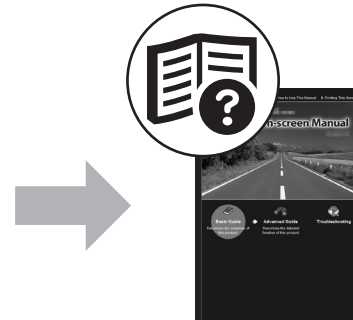

Basic Guide (on-screen manual)

Describes the basic operations and gives an introduction to other functions available.

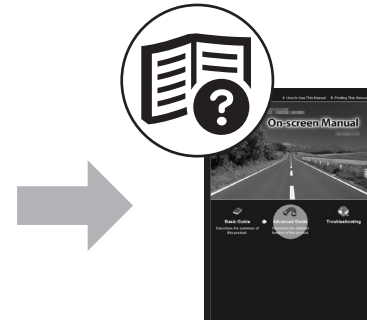

Advanced Guide (on-screen manual)

Describes various operating procedures to make full use of the printer. Also includes "Troubleshooting" information for your printer.



After Installing the Printer

■ Solution Menu

Solution Menu is a gateway to functions and information that allow you to make full use of the printer!



Example: Windows Vista



Open various applications and on-screen manuals with a single click.

You can start Solution Menu from the **Solution Menu** icon on the desktop (Windows) or on the Dock (Macintosh).

If you have a problem with printer settings, click the **Change settings or find solutions to problems** icon in Solution Menu to open **My Printer** (Windows only).

*The buttons displayed vary depending on the country or region of purchase.

■ Using Your Printer

This printer allows you to print in various ways using the printer driver and application software installed on the computer. For example, you can print borderless photos, and create your own calendar etc. easily.

For detailed operating procedures and functions, refer to the on-screen manuals.

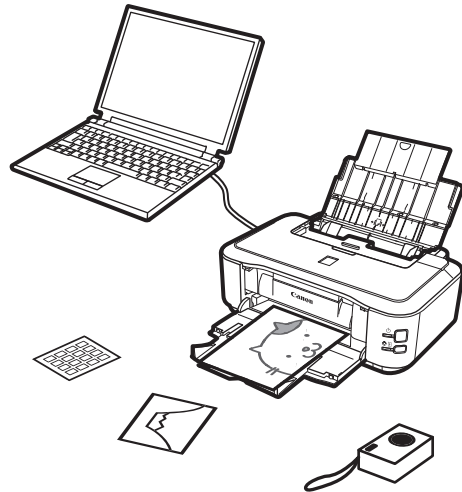

Now let's use the printer!



Print Photos from a Computer

Easy-PhotoPrint EX allows you to print photos easily.

This section explains how to print borderless photos using 4" x 6" size Photo Paper Plus Glossy II. The screens are based on Windows Vista.

1

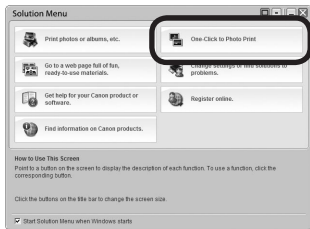

In Solution Menu, click **One-Click to Photo Print**.

Easy-PhotoPrint EX starts.

2

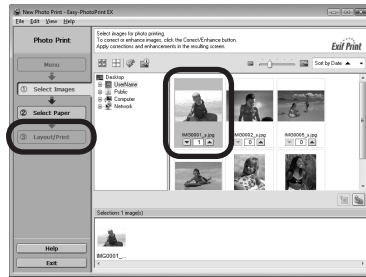

Select the image you want to print in a folder, then click **Layout/Print**.

When a photo is selected, the number of copies is set to "1."

3

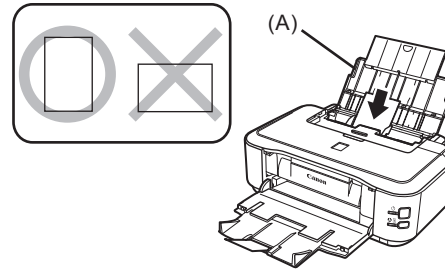

Load a sheet of photo paper in the Rear Tray (A) in portrait orientation.

Load paper with the printing side facing up.

4



Click **Print**.

Printing will start.



- For opening Solution Menu, refer to "Solution Menu" on page 26.
- For more information, refer to the on-screen manual: *Advanced Guide*.



- For details, refer to "6 Loading Paper" on page 22.



- On Macintosh, if the **Print** screen is displayed, click **Print** to start printing.

Aligning the Print Head

This section explains how to align the Print Head. The screens are based on Windows Vista. To cancel Print Head Alignment, click **Cancel** (**Quit** for Macintosh) on the dialog box.

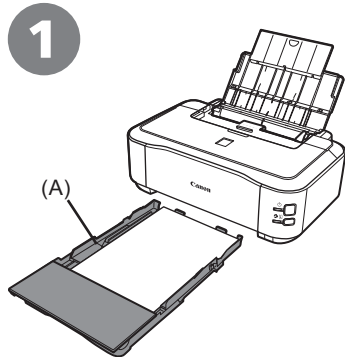

Load three or more sheets of A4 or Letter-sized plain paper into the Cassette (A).



- For details, refer to "6 Loading Paper" on page 22.

2

Windows

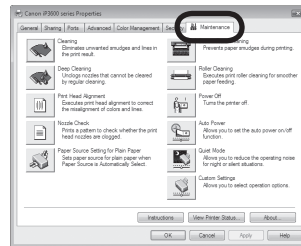

Macintosh



Select the **Maintenance** tab on the printer properties dialog box. (For Macintosh, select **Test Print** on the **Canon IJ Printer Utility**.)

See below for the procedures to open the printer properties dialog box and **Canon IJ Printer Utility**.

Windows

- 1 Click **Control Panel**, then **Printer** under **Hardware and Sound**.
- 2 Right-click the Canon iP3600 series icon and select **Properties**.

Macintosh

- 1 Select **System Preferences** from the **Apple** menu and click **Print & Fax**.
- 2 Double-click your printer's icon and click **Utility**.
- 3 Select your model from **Product** and click **Maintenance**.

3

Windows

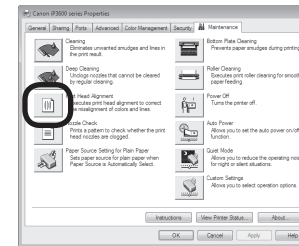

Macintosh

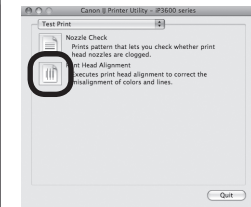

Select **Print Head Alignment** on the **Maintenance** tab of the printer properties dialog box. (For Macintosh, select **Print Head Alignment** for **Test Print** on the **Canon IJ Printer Utility**.)



Aligning the Print Head

4

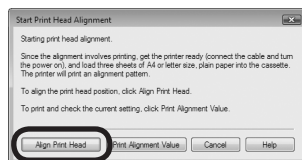
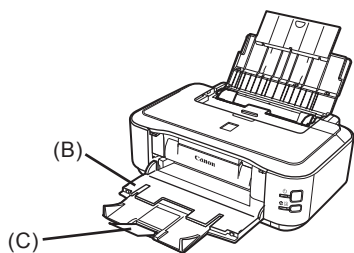

Confirm the displayed message and click **Align Print Head**.

When a message appears after clicking **Align Print Head**, click **OK**. Printing of the first pattern starts.

5

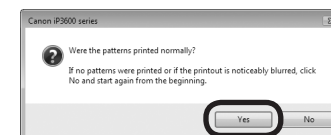

After the pattern is printed, click **Yes**.



- Do not open the Top Cover while printing.



- Make sure that the Paper Output Tray (B) and the Output Tray Extension (C) are open.

6

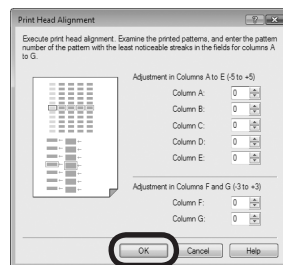
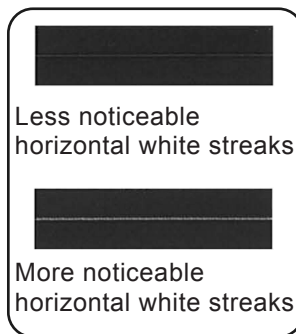
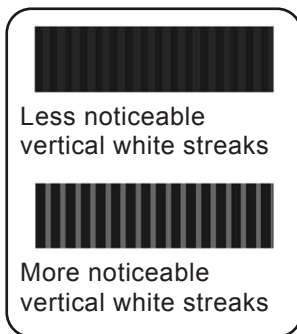

Look at the first printout and enter the number of the pattern that has the least noticeable vertical or horizontal streaks for columns A to G, then click **OK** (**Send** for Macintosh).



- If it is difficult to pick the best pattern, pick the setting that produces the least noticeable white streaks.

7

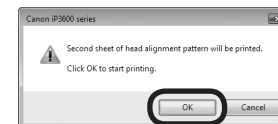

Confirm the displayed message and click **OK**.

Click **OK** in the subsequent message. Printing of the second pattern starts.



- Do not open the Top Cover while printing.

Aligning the Print Head

8

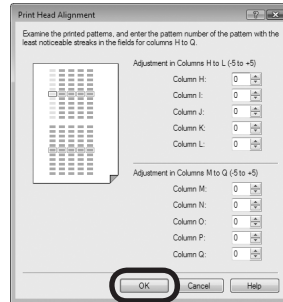
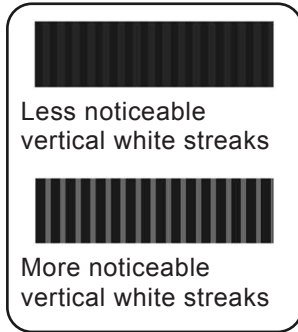

Look at the second printout and enter the number of the pattern that has the least noticeable vertical streaks for columns H to Q, then click **OK** (**Send** for Macintosh).

9

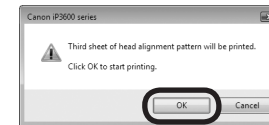

Confirm the displayed message and click **OK**.

Click **OK** in the subsequent message. Printing of the third pattern starts.

10

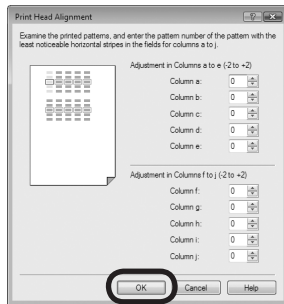
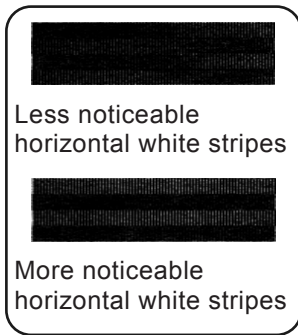

Look at the third printout and enter the number of the pattern that has the least noticeable horizontal stripes for columns a to j, then click **OK** (Send for Macintosh).



- If it is difficult to pick the best pattern, pick the setting that produces the least noticeable white stripes.

11



Click **OK** (Quit for Macintosh).

- Windows → Return to step 9 in "5 Install the Software" on page 14.
- Macintosh → Return to step 8 in "5 Install the Software" on page 20.

Return to the software installation procedure!

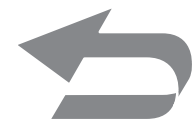



Specifications



General Specifications

Printing resolution (dpi)	9600 (horizontal)* x 2400 (vertical) * Ink droplets can be placed with a pitch of 1/9600 inch at minimum.
Interface	USB Port: Hi-Speed USB* Direct Print Port: PictBridge * A computer that complies with Hi-Speed USB standard is required. Since the Hi-Speed USB interface is fully upwardly compatible with USB 1.1, it can be used at USB 1.1.
Print width	8 inches / 203.2 mm (for Borderless Printing: 8.5 inches / 216 mm)
Acoustic noise level	Approx. 41.0 dB(A) * When printing in the standard print quality mode on Photo Paper Plus Glossy II.
Operating environment	Temperature: 5 to 35°C (41 to 95°F) Humidity: 10 to 90% RH (no condensation)
Storage environment	Temperature: 0 to 40°C (32 to 104°F) Humidity: 5 to 95% RH (no condensation)
Power supply	AC 100-240V, 50/60 Hz
Power consumption	Printing: Approx. 16 W Standby (minimum): Approx. 1.3 W* OFF: Approx. 0.5 W* * USB connection to PC
External dimensions	Approx. 17.0 (W) x 11.7 (D) x 6.0 (H) inches Approx. 431 (W) x 296 (D) x 153 (H) mm * With the Paper Support and Paper Output Tray retracted.
Weight	Approx. 5.6 kg (Approx. 12.2 lb) * With the Print Head and ink tanks installed.
Print Head/ink	Total 2,368 nozzles (DyeBK 320 nozzles, Y/PgBK each 256 nozzles, C/M each 768 nozzles)

Minimum System Requirements

 Conform to the operating system's requirements when higher than those given here.		
		
Operating System	Windows Vista	Mac OS X v.10.5
Processor	1 GHz processor	Intel processor, PowerPC G5, PowerPC G4 (867 MHz or faster)
RAM	512 MB	512 MB
	Windows XP SP2	Mac OS X v.10.4
	300 MHz processor	Intel processor, PowerPC G5, PowerPC G4, PowerPC G3
	128 MB	256 MB
	Windows 2000 Professional SP4	Mac OS X v.10.3.9
	300 MHz processor	PowerPC G5, PowerPC G4, PowerPC G3
	128 MB	128MB
	Note: Operation can only be guaranteed on a PC with Windows Vista, XP or 2000 pre-installed.	Note: Hard Disk must be formatted as Mac OS Extended (Journaled) or Mac OS Extended.
Browser	Internet Explorer 6.0 or later	Safari
Hard Disk Space	450 MB Note: For bundled software installation.	550 MB Note: For bundled software installation.
CD-ROM Drive	Required	
Display	SVGA 800 x 600	XGA 1024 x 768
	<ul style="list-style-type: none"> To upgrade from Windows XP to Windows Vista, first uninstall software bundled with the Canon inkjet printer. 	

Additional System Requirements for the on-screen manuals

	
Browser: Easy Guide Viewer Note: Microsoft Internet Explorer 6.0 or later must be installed. The on-screen manual may not be displayed properly depending on your operating system or Internet Explorer version. We recommend that you keep your system up to date with Windows Update.	Browser: Help Viewer Note: The on-screen manual may not be displayed properly depending on your operating system. We recommend that you keep your system up to date.

Specifications are subject to change without notice.

About Consumables

Consumables (ink tanks / FINE Cartridges) are available for 5 years after production has stopped.

Getting Help from Canon

Email Tech Support — www.canontechsupport.com

Toll-Free Live Tech Support— (1-800-828-4040)

This option provides live telephone technical support, free of service charges, Monday-Friday (excluding holidays), during the warranty period.

Telephone Device for the Deaf (TDD) support is available at (1-866-251-3752).

Ordering Information

The following ink tanks are compatible with this product.



Order

CLI-221 Black	2946B001
CLI-221 Magenta	2948B001
CLI-221 Yellow	2949B001
PGI-220 Black	2945B001
CLI-221 Cyan	2947B001

Call 1-800-OK-CANON to locate a dealer near you, or visit the Canon eStore at www.canonestore.com

www.usa.canon.com